

Signature™ Series Dome

Fixed Industrial Skylight



SIG | Frame Model 800MD

AVAILABLE CERTIFICATIONS

FM Approval # 4431
FBC 2020 - FL14086-R4 HVHZ Approved
Miami-Dade County, Florida, NOA No. 21-0318.03,
NFRC Certified
CE Certified
Class 4 Hail Ratings Available



Buy American: This product is assembled in the USA and meets the Buy America(n) government procurement requirements under FAR, DFARS and DOT. Please refer to [Build America, Buy America Act](https://www.buyusa.gov) federal website for additional information.

Warranty: 10-year and 15-year limited warranty available. Complete warranty terms located at: www.sunoptics.com

Note: Actual performance may differ as a result of end-user environment and application.

Specifications subject to change without notice.



PRODUCT PROFILE

Details Not To Scale

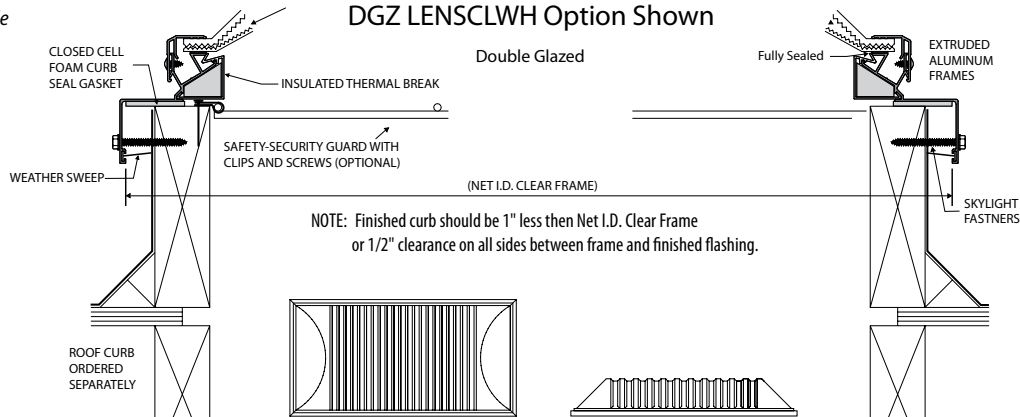

SPECIFICATIONS

Skylights shall be Sunoptics model 800MD (curb mounted) as manufactured by AES Sunoptics, Inc. Skylights shall be glazed ready for installation.

Skylight frames shall be fabricated from extruded aluminum, finish to be natural mill. Frames shall have integral condensation and weepage gutters which drain interior moisture to the outside. Corners shall be mitered and welded. The polycarbonate glazing shall be separated from the skylight frame with a Silicon Seal.

Skylights shall be glazed using CC1 rated, Prismatic polycarbonate in a Signature Series Dome configuration.

FM Approved Skylights shall be Double glazed using CLEAR ARMOUR® Clear Polycarbonate Prismatic over CLEAR ARMOUR® High White Polycarbonate Prismatic lens, CC1/Class A Rated, FM Approved.

FM Approved Skylights shall be tested and approved under Factory Mutual #4431 testing method for fixed skylights. Class A / CC1 flame rating. Standard Size units up to 5080 are tested and certified to AAMA/WDMA/CSA101/I.S.2/A440 to comply with 800MD frame section 2405.5 of the International Building Code.

Certain airborne contaminants can diminish the integrity of polycarbonate / acrylic lenses. Refer to the compatibility tables for suitable uses on our website.

Skylights not for use in Harsh, Corrosive, Marine and high-humidity Environmental Conditions such as Marina, Greenhouses, Petrol-Chemical facilities or other chemicals where the skylights may be exposed to such conditions.

Note: Multi-glazed units default to include Insulated Thermal Break (ITBR), Closed Cell Foam Curb Seal Gasket, Weather Sweep (WSW) and screws. Single-glazed units default to not included any of these options.

Testing was performed on HVHZ skylights per Florida Building Code, Test Protocols for High Velocity Hurricane Zone (HVHZ), Protocols TAS 201, TAS 202 and TAS 203. The samples tested met the performance requirements set forth in the protocols for a ±60.0 psf Design Pressure rating. Size units up to 5080 with 800MD frame are tested and listed for HVHZ.

Sunoptics HVHZ skylights are Miami-Dade County Product Control Approved.

Skylight Hail Class Rating

Material Type	Lens Material	Resistance Rating	Hail Size
Polycarbonate over Acrylic	CC1CC2	≤ Class 4	2"
Polycarbonate	CC1	≤ Class 4	2"

Skylight Thermal Performance

Type	SHGC	U-Value	VLT
Single Glazed	.68	n/a	.74
Double Glazed Clear/White	.42	.70	.64

Skylight Performance Grade Ratings

Short Description	Design Pressure
Polycarbonate Skylight	40 PSF
HVHZ Skylight	60 PSF

Cleaning Polycarbonate Lenses: Frequency of cleaning is determined by site conditions. When cleaning polycarbonate lenses, use only water or water with a mild soap. Use a soft rag to minimize scratching the polycarbonate. A pressure washer is acceptable to use as well. Never use ammonia, aromatic or petroleum based products to clean polycarbonate lenses. This will cause deterioration and cracking of the lens and will void the warranty.

Skylights should not be installed in locations with an operating temperature in excess of -75° F or 180°F.

Rates based on FGIA. See building standard AAMA/WDMA/CSA/101/I.S.2/A440

ORDERING LOGIC

Signature™ Series Dome

						▶▶▶
--	--	--	--	--	--	-----

Fixture	ID Frame Call-Out	ID Frame Width	ID Frame Length	Glazing	Lens Material					
SIG Signature Series	4040	51-1/4" x 51-1/4"	W51.250	Width 51.250 inches	L51.250	Length 51.250 inches	SGZ	Single Glaze	CC1	Polycarbonate
	4060	51-1/4" x 75-1/4"	W51.250	Width 51.250 inches	L75.250	Length 75.250 inches	DGZ	Double Glaze	CC1CC2	Poly/Acrylic
	4070	51-1/4" x 87-1/4"	W51.250	Width 51.250 inches	L87.250	Length 87.250 inches			CC1P125	1/8" Poly (Only available for skylights with a width of up to 52-1/4")
	4080	52-1/4" x 100-1/4"	W52.250	Width 52.250 inches	L100.250	Length 100.250 inches				
	5060	63-5/8" x 75-5/8"	W63.625	Width 63.625 inches	L75.625	Length 75.625 inches				
	5558	67-3/4" x 70-3/4"	W67.750	Width 67.750 inches	L70.750	Length 70.750 inches				
	5080	63-1/4" x 99-1/4"	W63.250	Width 63.250 inches	L99.250	Length 99.250 inches				

--	--	--	--

Lens Color	Unit Type	Skylight Frame Finish	Options
LENSWH	White (Single Glaze Default) ¹	800MD Standard Frame	MI Mill (Default)
LENSCLWH	Clear White (Double Glaze Default) ²	900SC So-Cal Skylight	
			(blank) No Options
			FMRTG Factory Mutual Approved
			HVHZ High Velocity Hurricane Zone/ Miami Dade NOA***
			ITBR Insulated thermal break ¹
			NITBR No Insulated Thermal Break ^{2,3}
			WSW Weather Sweep** ¹
			NWSW No Weather Sweep ^{2,3}

* mold fee may apply ** weather sweep available with Mill finish only ***Select CC1CC2 Lens material for HVHZ skylights (includes: FL 14086-R4 & Miami-Dade County, Florida, NOA No. 21-0318.03. Exp: 05/20/26).
 1) Single Glaze 2) Double Glaze

